

이 도면상에 표시된 정보는 (주)효성의 소유이며 당사의 사전 서면동의 없이 무단사용을 금합니다. The information written in this drawing is HYOSUNG's property, and may not be disclosed and/or reproduced without the prior official permission of HYOSUNG Corp.

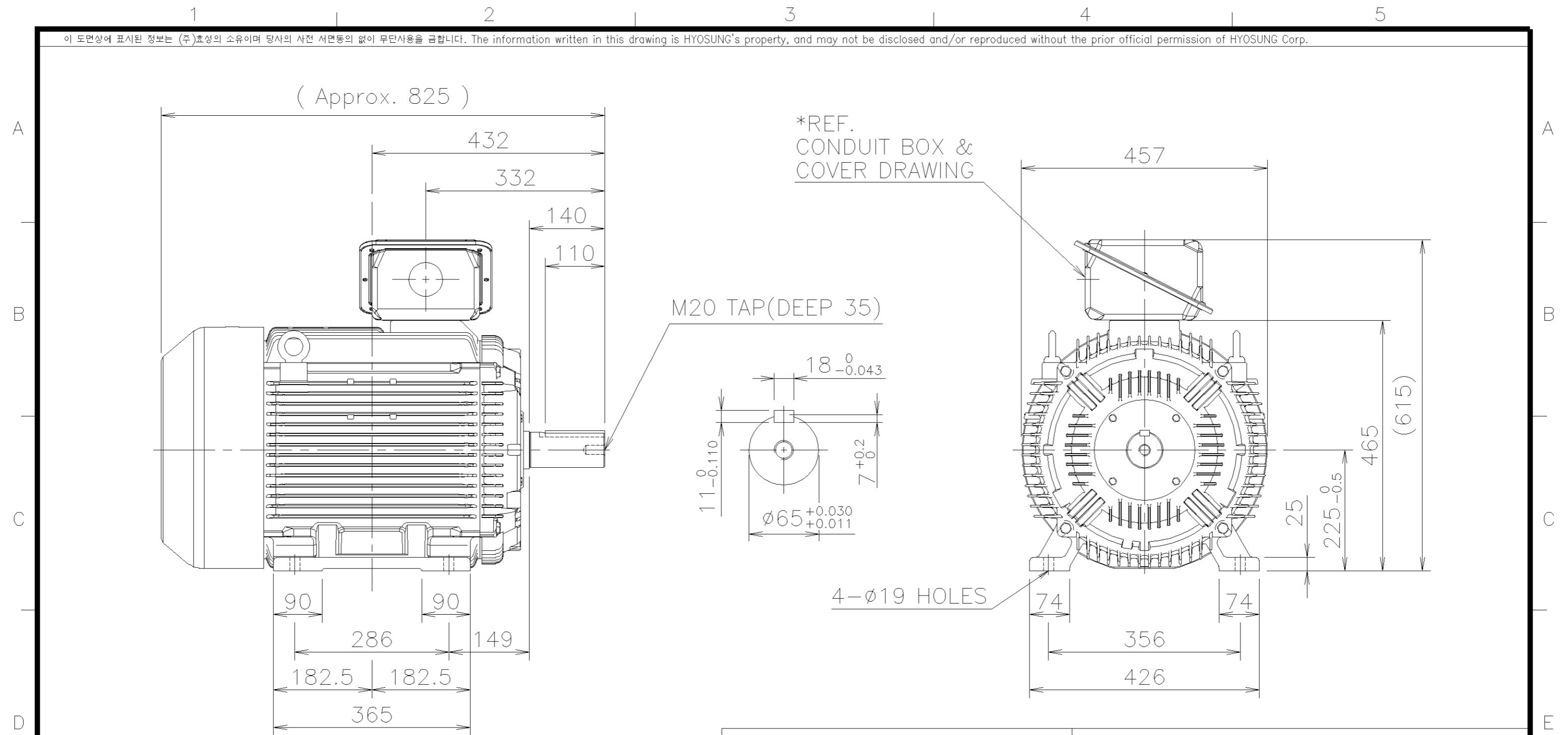

<NOTE>

- 1) THE CONDUIT BOX MAY BE ROTATED STEPS OF 90°.
- 2) STEEL HOOD & STEEL C/B.

TYPE AC MOTOR TEFC FR.225S 4P~					DWG. NAME OUTLINE DIMENSIONS				
DRAWN	DESIGN	CHECKED	REVIEWED	APPROVED		SCALE	1/10	DATE	2011-06-07
	심 2011/06/27 상미	고 2011/06/27 효림	박 2011/06/27 종근	이 2011/06/28 경순	REF. DWG. NO.				UNIT mm
					DWG. NO.	DMMK10924H04			